

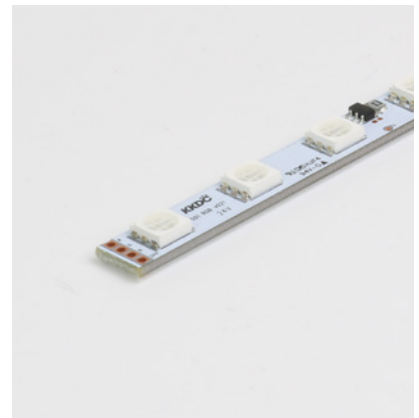

TIMI RGB Fixture Guide



Indoor | Surface | RGB Output



Key applications

- ✓ Architectural detail
- ✓ Backlighting & signage
- ✓ Cabinet & furniture
- ✓ Cove lighting
- ✓ Display case
- ✓ Indirect lighting
- ✓ Interior
- ✓ Mirror back lighting
- ✓ Retail display
- ✓ Shelving display
- ✓ Special effect

Key features

- ✓ Custom lengths
- ✓ Cutable (IP20)
- ✓ Constant Voltage (CV)
- ✓ Diffusion: spoting
- ✓ IP20 dry area
- ✓ Light on time (10 day delivery)
- ✓ Lens options
- ✓ RGB

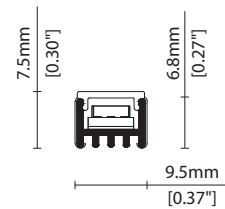

MOUNTING METHODS



KKCP-13 Lock clip

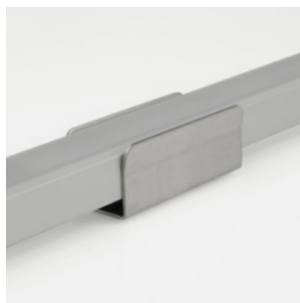

KKCP-01 Standard clip



KKCP-05 Lens lock clip



Inside lens accessory

Linear

TIMI RGB

Specification sheet



| | |
|-----------------------|---|
| Dimensions | H6.8/W9.5/L97-2014mm (H0.27/W0.37/L3.81-79.29in) (Double tail) / H6.8/W9.5/L90-2007mm (H0.27/W0.37/L3.54-79.01in) (Single tail) |
| PCB Cut-point | 83.3mm increment/2000mm max (3.28in increment/78.74in max) |
| LED Pitch | 13.9mm-72LED/m (0.55in - 22LED/ft) |
| Chip | RGB |
| Cover/Optics | No cover (120°) / Semi-diffused (100°) / Black (90°) / KKLN-01 lens (14° or 36°) |
| CCT | Red 620-625nm/Blue 455-460nm/Green 520-525nm |
| LED binning | 5nm tolerance |
| CRI | N/A |
| Lifetime | 30,000 hours @ 25°C (30,000 hours @ 77°F) |
| Operating temp | T _a = -25 to 50°C (T _c max = 80°C) T _a = -13 to 122°F (T _c max = 176°F) |
| IP Rating | IP20 |
| Finish | Silver anodised |
| Mounting | Surface mounting via clips |
| Power feed | Hardwire tails or male/female connectors |
| Control | DMX/DALI |

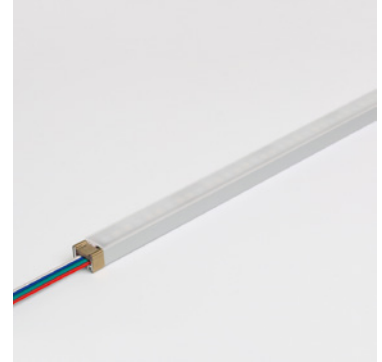

| | | |
|--------------------------|-----------------------|-----------------------|
| Power consumption | Supply voltage | Supply current |
| 15.6W/m (4.75W/ft) | 24V DC | 0.65A/m (0.20A/ft) |

| No Cover | Semi-diffused | 14° (KKLN-01) | 36° (KKLN-01) | Black cover |
|---|---|---|---|---|
| Red: 150lm/m (46lm/ft) Green: 320lm/m (98lm/ft) Blue: 50lm/m (15lm/ft) RGB: 460lm/m (140lm/ft) | Red: 120lm/m (37lm/ft) Green: 270lm/m (82lm/ft) Blue: 40lm/m (12lm/ft) RGB: 390lm/m (119lm/ft) | Red: 140lm/m (43lm/ft) Green: 300lm/m (91lm/ft) Blue: 50lm/m (15lm/ft) RGB: 440lm/m (140lm/ft) | Red: 140lm/m (43lm/ft) Green: 300lm/m (91lm/ft) Blue: 50lm/m (15lm/ft) RGB: 430lm/m (131lm/ft) | Red: 40lm/m (12lm/ft) Green: 85lm/m (26lm/ft) Blue: 13lm/m (4lm/ft) RGB: 125lm/m (38lm/ft) |

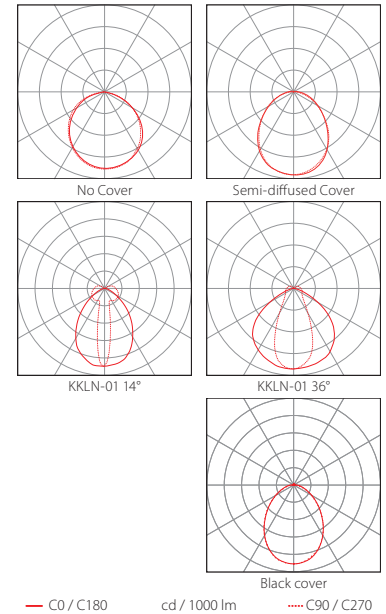
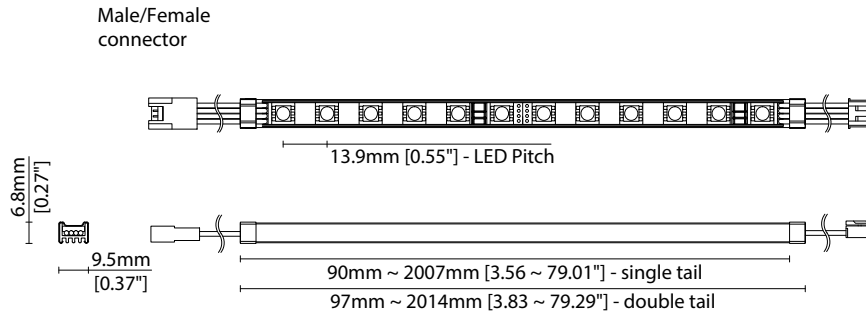

Data derived from production samples tested to UKAS/IESNA LM-79-08 standards.

FIXTURE

| Model | Finish | Cover/Lens ¹ | Grade | LED | Colour (CCT) | Length Availability ² | IP | Cable Length | Power Feed ³ | Input | | | | | | | | | | |
|-------|--------|-------------------------|-------|-----------------------------|--------------|---|-----|--------------|-------------------------|-------|---|------|----|-----------------|------|---------------------------------|------|--------|---|--|
| TIMI | TI | Silver Anodised | SA | No cover ⁴ | X |  s | 501 | RGB | RGB | m | 97-2014mm ⁵ 90-2007mm ⁶ 83.3mm increments | IP20 | 20 | 50mm (1.97in) | 0050 | Single no sheath tail | S00X | DC 24V | g | |
| | | | | Semi-diffused ⁴ | D | | | | | i | 3.83-79.29in ⁵ 3.56-79.01in ⁶ 3.28in increments | | | 300mm (11.81in) | 0300 | Double no sheath tail | D00X | | | |
| | | | | KKLN-01D (14°) ⁵ | S | | | | | | | | | | | Single no sheath IP20 connector | S20X | | | |
| | | | | KKLN-01U (36°) ⁵ | R | | | | | | | | | | | | | | | |
| | | | | Black cover ⁵ | Y | | | | | | | | | | | Double no sheath IP20 connector | D20X | | | |

¹ Refer to **Cover/Lens Options** on **Options** pages

² Refer to **Length Availability List** or enter total run length instead of length code

³ Refer to **Power Feed Options** on **Options** pages

⁴ Operating temperatures vary for TIMI with cover and TIMI without cover; please check with a KKDC engineer if operating temperature is limiting product application

⁵ Double clamp TIMI length

⁶ Single clamp TIMI length

Code Example:

| | | | | | | | | | | | | | | | | | | | | | | |
|------|---|-----------------|---|---------------|---|---|---|-----|---|-----|---|---|---|-------|---|------|---|---------------|---|---------------------------------|---|--------|
| TI | - | SA | - | D | - | s | - | 501 | - | RGB | - | m | - | 514 | - | 20 | - | 0050 | - | D20X | - | g |
| TIMI | | Silver Anodised | | Semi-diffused | |  | | 501 | | RGB | | m | | 514mm | | IP20 | | 50mm (1.97in) | | Double no sheath IP20 connector | | DC 24V |

ACCESSORIES

Mounting Accessories

| | |
|---------|-------------------------------------|
| KKCP-01 | Clip (1no.) |
| KKCP-51 | Clip (500no.) |
| KKCP-13 | Lock Clip |
| KKCP-05 | Lens Lock Clip for KKLN-01 (1no.) |
| KKCP-55 | Lens Lock Clip for KKLN-01 (500no.) |

* Refer to **Mounting accessories** on **Accessories** pages

Connection Accessories

| | |
|---------|--|
| KKCN-07 | 4 PIN RGB male & female 50mm (1.97in) pair |
| KKCN-09 | 4 PIN RGB male & female 300mm (11.81in) pair |
| KKCN-11 | 4 PIN RGB 300mm (11.81in) extension lead |

* Refer to **Power feed** on **Accessories** pages

PSU/Driver

DALI/DMX

* Refer to **Driver/PSU Options** page for details or provide requirement and KKDC to offer the suitable option

LED ENGINE VARIANTS (LED STRIP TYPE)

| Colour | LED | Lumen/m | Lumen/ft | W/m | W/ft | Spec Doc | Length | Increment |
|------------------------|------|--|--|------|------|-----------|--------------------------|------------------|
| Single CCT | R007 | 680 | 207 | 7 | 2.13 | TIMI R007 | 97-2014mm (3.81-79.29in) | 41.7mm (1.64in) |
| | R014 | 1380 | 421 | 14 | 4.27 | TIMI R014 | 97-2014mm (3.81-79.29in) | 41.7mm (0.27in) |
| | A010 | 1400 | 426 | 10 | 3.05 | TIMI A010 | 91-2014mm (3.58-79.29in) | 38.46mm (1.51in) |
| | A020 | 2800 | 853 | 20 | 6.10 | TIMI A020 | 91-2014mm (3.58-79.29in) | 38.46mm (1.51in) |
| Warm Dim/Dynamic White | R207 | 1476 | 450 | 16 | 4.88 | TIMI R207 | 97-2014mm (3.81-79.29in) | 83.3mm (0.55in) |
| RGB | 501 | Red: 150 Green: 320 Blue: 50 RGB: 460 | Red: 46 Green: 98 Blue: 15 RGB: 140 | 15.6 | 4.88 | TIMI RGB | 97-2014mm (3.81-79.29in) | 83.3mm (3.28in) |

* Performance data: no cover, RGB

TIMI RGB

Length Availability List



| Length Code | | Fixture Length ¹ | | LED Strip ² | | End Cap Dimension | | Wattage (W) | Output (lm) | | | |
|-------------|--------------|-----------------------------|--------------|------------------------|--------------|-------------------|--------------|-------------|-------------|-----|-----|-----|
| Metric | Imperial(US) | Metric | Imperial(US) | Metric | Imperial(US) | Metric | Imperial(US) | | R | G | B | W |
| m0097 | i0004 | 97mm | 3.83in | 83mm | 3.28in | N/A | N/A | 1.30 | 13 | 27 | 4 | 38 |
| m0181 | i0007 | 181mm | 7.11in | 167mm | 6.56in | N/A | N/A | 2.60 | 25 | 53 | 8 | 77 |
| m0264 | i0010 | 264mm | 10.39in | 250mm | 9.84in | N/A | N/A | 3.90 | 38 | 80 | 13 | 115 |
| m0347 | i0014 | 347mm | 13.68in | 333mm | 13.12in | N/A | N/A | 5.20 | 50 | 107 | 17 | 153 |
| m0431 | i0017 | 431mm | 16.96in | 417mm | 16.41in | N/A | N/A | 6.50 | 63 | 133 | 21 | 192 |
| m0514 | i0020 | 514mm | 20.24in | 500mm | 19.69in | N/A | N/A | 7.80 | 75 | 160 | 25 | 230 |
| m0597 | i0024 | 597mm | 23.52in | 583mm | 22.97in | N/A | N/A | 9.10 | 88 | 187 | 29 | 268 |
| m0681 | i0027 | 681mm | 26.80in | 667mm | 26.25in | N/A | N/A | 10.40 | 100 | 213 | 33 | 307 |
| m0764 | i0030 | 764mm | 30.08in | 750mm | 29.53in | N/A | N/A | 11.70 | 113 | 240 | 38 | 345 |
| m0847 | i0033 | 847mm | 33.36in | 833mm | 32.81in | N/A | N/A | 13.00 | 125 | 267 | 42 | 383 |
| m0931 | i0037 | 931mm | 36.64in | 917mm | 36.09in | N/A | N/A | 14.30 | 138 | 293 | 46 | 422 |
| m1014 | i0040 | 1014mm | 39.92in | 1000mm | 39.37in | N/A | N/A | 15.60 | 150 | 320 | 50 | 460 |
| m1097 | i0043 | 1097mm | 43.21in | 1083mm | 42.65in | N/A | N/A | 16.90 | 163 | 347 | 54 | 498 |
| m1181 | i0046 | 1181mm | 46.49in | 1167mm | 45.94in | N/A | N/A | 18.20 | 175 | 373 | 58 | 537 |
| m1264 | i0050 | 1264mm | 49.77in | 1250mm | 49.22in | N/A | N/A | 19.50 | 188 | 400 | 63 | 575 |
| m1347 | i0053 | 1347mm | 53.05in | 1333mm | 52.50in | N/A | N/A | 20.80 | 200 | 427 | 67 | 613 |
| m1431 | i0056 | 1431mm | 56.33in | 1417mm | 55.78in | N/A | N/A | 22.10 | 213 | 453 | 71 | 652 |
| m1514 | i0060 | 1514mm | 59.61in | 1500mm | 59.06in | N/A | N/A | 23.40 | 225 | 480 | 75 | 690 |
| m1597 | i0063 | 1597mm | 62.89in | 1583mm | 62.34in | N/A | N/A | 24.70 | 238 | 507 | 79 | 728 |
| m1681 | i0066 | 1681mm | 66.17in | 1667mm | 65.62in | N/A | N/A | 26.00 | 250 | 533 | 83 | 767 |
| m1764 | i0069 | 1764mm | 69.45in | 1750mm | 68.90in | N/A | N/A | 27.30 | 263 | 560 | 88 | 805 |
| m1847 | i0073 | 1847mm | 72.74in | 1833mm | 72.18in | N/A | N/A | 28.60 | 275 | 587 | 92 | 843 |
| m1931 | i0076 | 1931mm | 76.02in | 1917mm | 75.47in | N/A | N/A | 29.90 | 288 | 613 | 96 | 882 |
| m2014 | i0079 | 2014mm | 79.30in | 2000mm | 78.75in | N/A | N/A | 31.20 | 300 | 640 | 100 | 920 |

¹ Actual total overall length of light fixture (LED strip + end caps + void/wire hole)

² Actual length of PCB strip

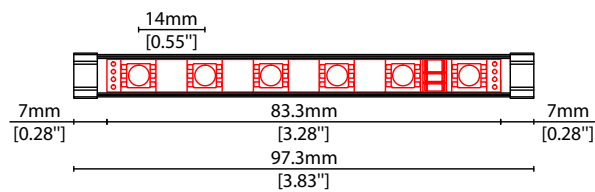

COVER/LENS OPTIONS

* Options are an integral part of the fixture ordering codes. Please refer to **Code Table** pages.

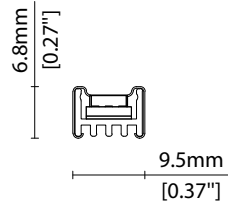

X No cover
W9.5/H6.8mm (W0.37/H0.27")

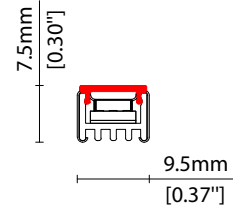

D Semi-diffused cover
Polycarbonate finish
W9.5/H7.5mm (W0.37/H0.30")

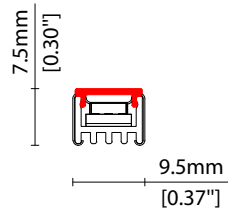

Y Black semi-diffused cover
Black translucent PMMA
25% light output
W9.5/H7.5mm (W0.37/H0.30")

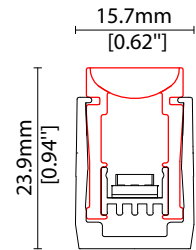

S 14° lens (KKLN-01D)
14° beam linear lens,
co-extruded PMMA
W12.8/H20mm (W0.5/H0.79")

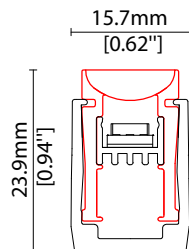

R 36° lens (KKLN-01U)
36° beam linear lens,
co-extruded PMMA
W12.8/H20.4mm (W0.5/H0.8")

POWER FEED OPTIONS

* Options are an integral part of the fixture ordering codes. Please refer to **Code Table** pages.

0050 S20X 50mm (1.97") Single no sheath IP20 connector

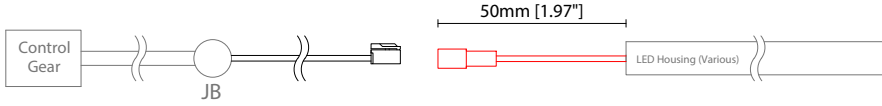

0050 D20X 50mm (1.97") Double no sheath IP20 connector

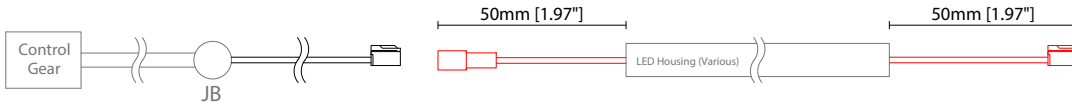

0300 S00X 300mm (11.81") Single no sheath tail

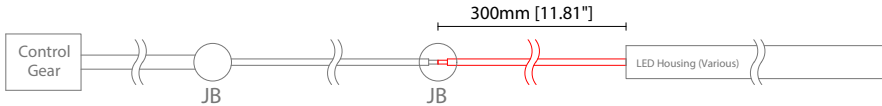

0300 D00X 300mm (11.81") Double no sheath tail

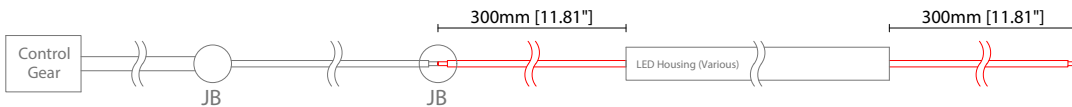

0300 S20X 300mm (11.81") Single no sheath IP20 connector

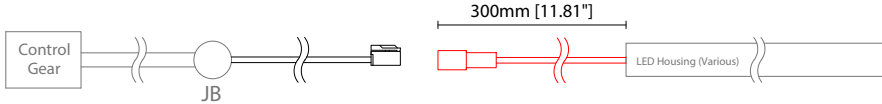

0300 D20X 300mm (11.81") Double no sheath IP20 connector

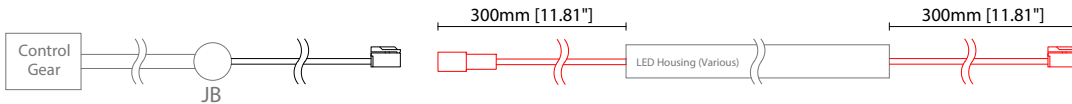

4 Pin RGB Female Connector

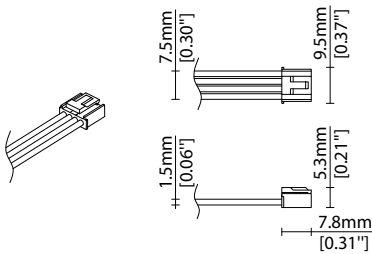

4 Pin RGB Male Connector

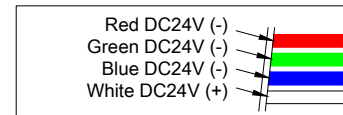
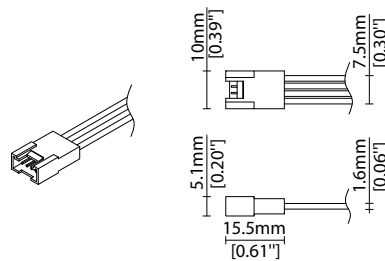

Key

Control Gear Power supply, sub-controllers & control systems

JB Junction box / cable connection

MOUNTING ACCESSORIES

Note: Accessories are to be ordered separately with corresponding code shown below.

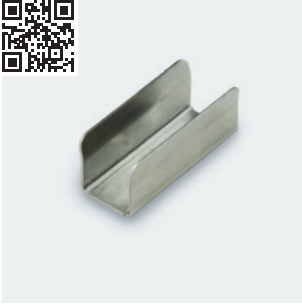

KKCP-01 (1no.)
KKCP-51 (500no.)
Clip (allow 3 per metre/40in)
S/Steel finish
L25/W11.8/H10.4mm
(L0.98/W0.46/H0.41")

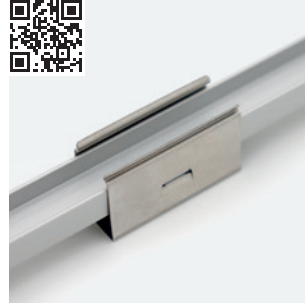
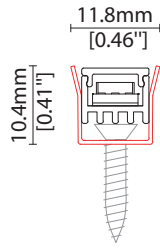

KKCP-13
Lock clip (allow 2 per metre/40in)
S/Steel finish
L25/W10.8/H14.5mm
(L0.98/W0.43/H0.57")

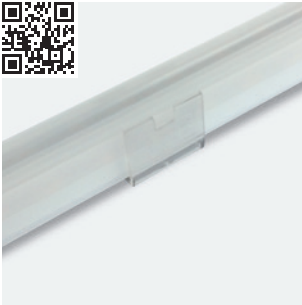
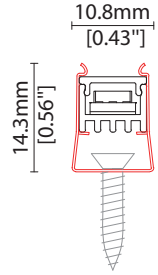

KKCP-05 (1no.)
KKCP-55 (500no.)
For use with KKLN-01 lens only
Lens lock clip (allow 3 per metre/40in)
Clear polycarbonate finish
L25/W15.6/H24mm
(L0.98/W0.61/H0.94")

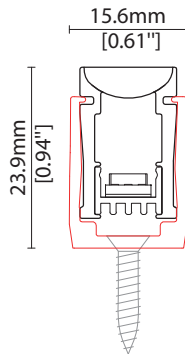

POWER FEED

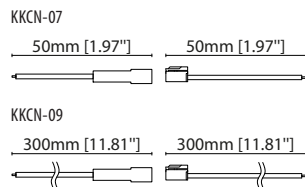
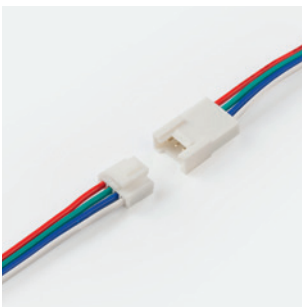

KKCN-07 50mm (1.97in) pair
KKCN-09 300mm (11.81in) pair
4 PIN RGB male + female
connector set

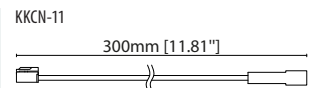

KKCN-11
4 PIN RGB 300mm (11.81in)
extension lead

KKDC CONTROL



IP20
Plastic housing
L170/W59/H29mm
(L6.69/W2.32/H1.14in)

KKDM-06 1-10V

visDIM dimmable sub-controller
(4 x 8A max @ 12-36V)



IP20
Plastic housing
L170/W53.4/H28mm
(L6.69/W2.10/H1.10in)

KKSC-05 DMX

visDIM dimmable sub-controller
(4 x 5A max @ 12-36V)



IP20
Plastic housing
L170/W59/H29mm
(L6.69/W2.32/H1.14in)

KKDL-02 DALI

visDIM dimmable sub-controller
(4 x 8A max @ 12-36V)



IP20
Plastic housing
L166/W53.4/H23mm
(L6.54/W2.10/H0.91in)

KKDL-03 DALI

visDIM dimmable sub-controller
(4 x 5A max @ 12-36V)

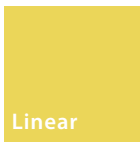

TIMI

Driver/PSU Options



AVAILABLE PSU OPTIONS

| Control Mode | PSU (Order Code) | Input Voltage AC | Output Voltage DC | Rated Output Current | Rated Power | Dim % | IP Rating |
|---------------|------------------|------------------|-------------------|----------------------|-------------|-------------------|-----------|
| Switched | CEN-60-24 | 90-295V | 24V | 2.5A | 60W | - | IP67 |
| | HLG-60H-24 | 90-305V | 24V | 2.5A | 60W | - | IP67 |
| | HLG-100H-24 | 90-305V | 24V | 4.0A | 100W | - | IP67 |
| | HLG-150H-24 | 90-305V | 24V | 6.3A | 150W | - | IP67 |
| | HLG-240H-24 | 90-305V | 24V | 10A | 240W | - | IP67 |
| 0-10V (1-10V) | PWM-40-24 | 90-305V | 24V | 1.67A | 40W | 100-0.15 (100-10) | IP67 |
| | PWM-60-24 | 90-305V | 24V | 2.5A | 60W | 100-0.15 (100-10) | IP67 |
| | PWM-90-24 | 90-305V | 24V | 3.67A | 90W | 100-0.15 (100-10) | IP67 |
| | PWM-120-24 | 90-305V | 24V | 5.0A | 120W | 100-0.15 (100-10) | IP67 |
| DALI | LIN100A1 | 120-277V | 24V | 1A per channel | 100W | 100-0.1 | IP66/IP40 |
| DMX RGB | LIN100A1 | 120-277V | 24V | 1.33A per channel | 100W | 100-0.1 | IP66/IP40 |
| DMX RGBW | LIN100A1 | 120-277A | 24V | 1A per channel | 100W | 100-0.1 | IP66/IP40 |

Flicker Free Options - Combination of PSU+ sub-controller

| Control Mode | PSU (Order Code) | Sub-controller (Order Code) | Input Voltage AC | Output Voltage DC | Rated Output Current | Rated Power | Dim % | IP Rating PSU/ Sub-controller |
|----------------|------------------|-----------------------------|------------------|-------------------|----------------------|-------------|---------|-------------------------------|
| 0-10V or 1-10V | CEN-60-24 | KKDM-06 | 90-295V | 24V | 2.5A | 60W | 100-0.9 | IP67/IP20 |
| | HLG-60H-24 | KKDM-06 | 90-295V | 24V | 2.5A | 60W | 100-0.9 | IP67/IP20 |
| | HLG-100H-24 | KKDM-06 | 90-295V | 24V | 4.0A | 100W | 100-0.9 | IP67/IP20 |
| | HLG-150H-24 | KKDM-06 | 90-295V | 24V | 6.3A | 150W | 100-0.9 | IP67/IP20 |
| | HLG-240H-24 | KKDM-06 | 90-295V | 24V | 10.0A | 240W | 100-0.9 | IP67/IP20 |
| DALI | CEN-60-24 | KKDL-02/03 | 90-295V | 24V | 2.5A | 60W | 100-0.1 | IP67/IP20 |
| | HLG-60H-24 | KKDL-02/03 | 90-305V | 24V | 2.5A | 60W | 100-0.1 | IP67/IP20 |
| | HLG-100H-24 | KKDL-02/03 | 90-305V | 24V | 4.0A | 100W | 100-0.1 | IP67/IP20 |
| | HLG-150H-24 | KKDL-02/03 | 90-305V | 24V | 6.3A | 150W | 100-0.1 | IP67/IP20 |
| | HLG-240H-24 | KKDL-02/03 | 90-305V | 24V | 10.0A | 240W | 100-0.1 | IP67/IP20 |
| DMX RGB | CEN-60-24 | KKSC-05 | 90-295V | 24V | 2.5A | 60W | 100-0.9 | IP67/IP20 |
| | HLG-60H-24 | KKSC-05 | 90-305V | 24V | 2.5A | 60W | 100-0.9 | IP67/IP20 |
| | HLG-100H-24 | KKSC-05 | 90-305V | 24V | 4A | 100W | 100-0.9 | IP67/IP20 |
| | HLG-150H-24 | KKSC-05 | 90-305V | 24V | 6.3A | 150W | 100-0.9 | IP67/IP20 |
| | HLG-240H-24 | KKSC-05 | 90-305V | 24V | 10.0A | 240W | 100-0.9 | IP67/IP20 |

¹ The items shown above cover the most frequently used specification but does not exhaust the possible options

² PSU and/or driver can be chosen from the table, or KKDC may recommend the best option upon receipt of the controls requirement and installation environment

³ Electrical shop drawing will include detailed information of PSU and relevant control drivers

⁴ Cut sheets are available on the controls section of www.kkdc.lighting or upon request